

K

2020  
MINTEX



*Spare Parts &*

*Attachment of Lingerie*

女仕服裝縫製設備

SPARE PARTS & ATTACHMENT OF

LINGERIE

ЖЕНСКОЕ БЕЛЬЕ

## 內容 Contents

	頁數 Page
胸罩製作圖解 Brassiere Production Illustration	A, B
<b>人字縫 Zigzag</b>	
標準壓腳 Standard Feet	1
針板及送布齒 Needle Plate & Feed Dog	2
導傍及高低壓腳 Guiding & Compensating Feet	3
細條及鬆緊帶 Tape & Elastic	6
包邊及摺邊 Binding & Hemming	9
擺針凸輪 Needle Vibrating Cam	12
透明塑膠壓腳 Transparent Plastic Presser Feet	14
接合縫及底細條 Butting Seam & Undertape	15
特別應用人字縫零件 Zigzag Parts for Special Application	15
百福人字縫 Pfaff Zigzag	16
<b>雙針 Double Needles</b>	
胸罩杯及鋼線助縫設備 Attachment for Bra Cup & Underwire	17
面貼細條－助縫設備 Tape Attaching - Attachment	18
面貼細條－壓腳 Tape Attaching - Attaching Feet	19
面貼細條－針位 Tape Attaching - Gauge Set	20
包邊針位 Binding Gauge Set	22
其他針位 Other Gauge Set	22
<b>其他 Others</b>	
鬆緊帶調節器 Tension Device	24
其他配件 Other Parts	25
送料器 Tape Feeder	27

## 胸罩製作圖解 Brassiere Production Illustration

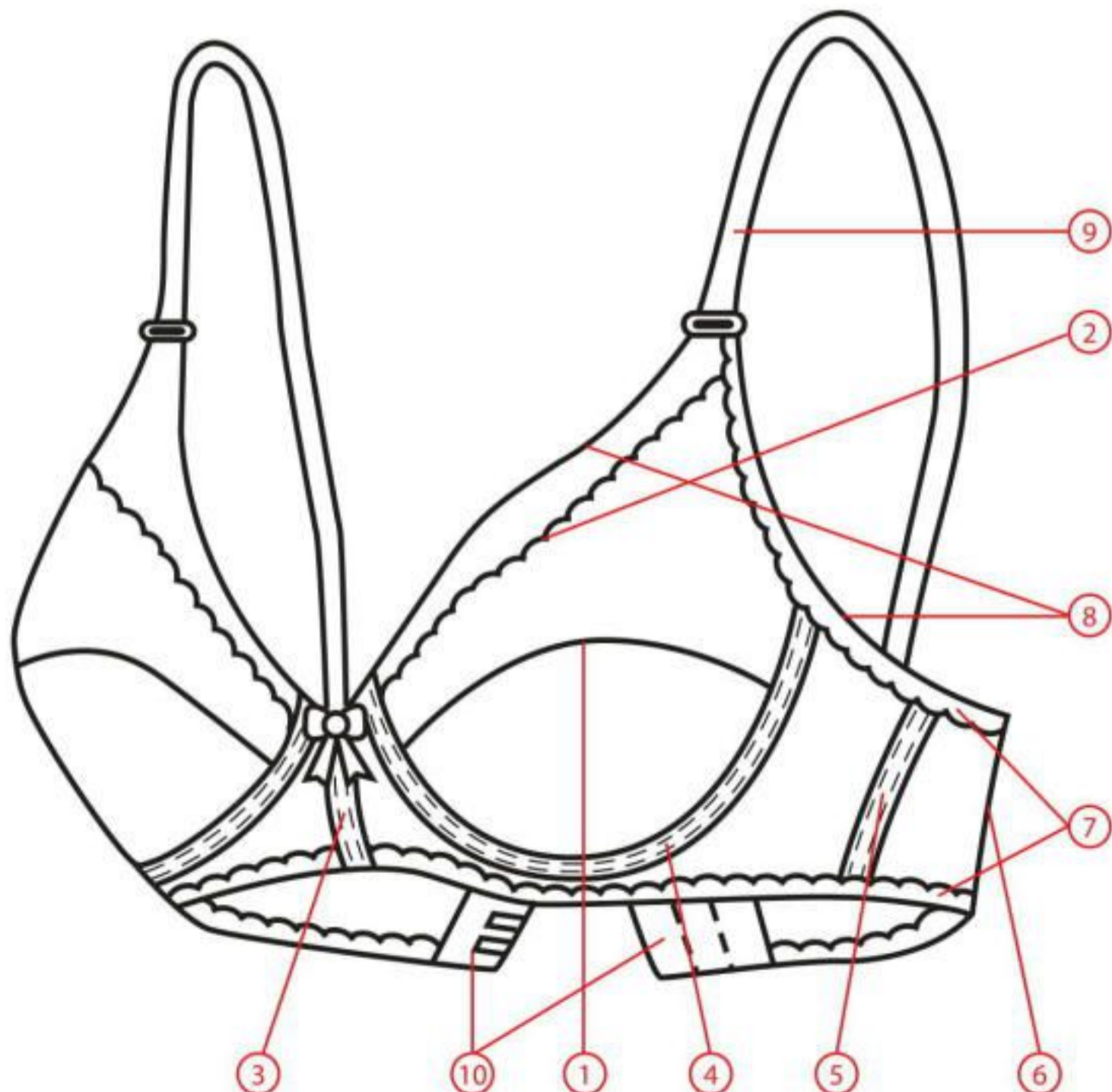

零件號 Parts Number	頁數 Page
23770, 23770K	7
22815 & 22223	15
22187 & 22223	15
24711	18
KHF63	18
21010	20
23061	20
23071	20
23207	20
224053 & 224029	22



## 1. 杯位合併縫及襯裡 Butting Seam for Cup

210604 & 210524	2
22186 & 417921	2
503733N & 503734N	2
503605 & 541647	2
51768 & 417920	3
107-4L, 107-5L	3
107-6L	4
107-CL	4
107-DL, 107-DR	4
266125, 3706, 3707	5
107-029, 107-029K	6
107-G5L	6
23769	6
23781	8
210562A, 210516A, 210596A	11
KHF81	18
212-684	18
212-005A	19
212-112	19
23072	20
SP-18N	25
KHF83	25



## 2. 杯位紗網及花邊 Lace On The Cup Piece

KHF71	17
24711	18
21139	19
23073	20
21010	20
224053 & 224029	22
212-112K	22
23069	23
KH373-75	25







## 3. 胸罩中央部份 Center Piece

KHF68	17
KHF71	17
KHF77	17
KHF78	17
KHF92	17
KHF97	17
KHF99	18
KHF38	18
KHF63	18
24711	18
21140	19
23061	20
23207	20
21010	20
S570AL, S570AR	21
223884H & 223628H	21
21014	22
224053 & 224029	22
223773	23
23388	23

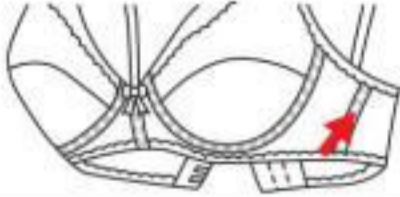
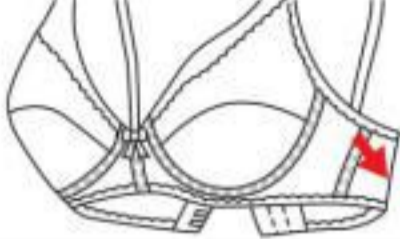

## 4. 胸杯接合及鋼圈加固 Cups Setting and Underwire

		零件號 Parts Number	頁數 Page
<b>5.</b> 兩側及背部硬片 Brassiere Strip Supporting		KHF63	18
		KHF96, 212-96	18
		23061	20
<b>6.</b> 中央、兩側及背部合併 Join Side and Back Piece to Center Piece		212-005A	19
		212-112	19
		21010	20
		23071	20
		23073	20
<b>7.</b> 鬆緊帶 Elastic Tape		210603, 210523	2
		51768, 417920	3
		107-030	6
		107-G5L	6
		23766A	6
		23769	6
		23771, R23771	7
		23771R, 23771S	7
		23772	7
		23779	7
		23779A, 23779R, 23780	8
		23781, 23782	8
		23425	8
		603766	8
		B109	9
		R438CK, 438GA, 438GA-1	16
		438C	16
		KHF36	22
		457G-188, 457T1, 457T2, KH457-T1, KH457-T2	24
<b>8.</b> 包邊縫 Binding		KHF47	9
		210569-A, 210569-B	10
		KHF76	10
		KHF79	10
		KHF59	11
		210562A, 210516A, 210596A	11
		KHF36	22
		K10	25
		KHF57, KHF62	26
<b>9.</b> 肩帶 Straps		23766A	6
		23771, R23771	7
		23782	8
		23425	8
		603766	8
		457G-188, 457T1, 457T2, KH457-T1, KH457-T2	24
		KHF57, KHF62	24
			26
<b>10.</b> 背扣 Eye and Hook		107-086	1
		107-254	1
		241375	1
		503733N, 503734N	2
		210603 & 210523	2
		210604 & 210524	2
		107-CL	4
		107-DL, 107-DR	4
		266125, 3706, 3707	5
		235-12551	15
		KH373-86	25
107-089, 210595, 210515	26		

# K 標準壓腳

## Standard Feet



### 107-086

壓腳寬度  
Presser Foot Width:  
10mm



### 107-254

壓腳寬度  
Presser Foot Width:  
14.5mm



### 210569

壓腳寬度  
Presser Foot Width:  
15mm



### 241375

壓腳寬度  
Presser Foot Width:  
11mm



### 411314

壓腳寬度  
Presser Foot Width:  
17mm



### 503595

壓腳寬度  
Presser Foot Width:  
18.7mm



### 503689

壓腳寬度  
Presser Foot Width:  
16mm



## 503690

壓腳寬度  
Presser Foot Width:  
19mm

# K 針板及送布齒 Needle Plate & Feed Dog



## 210600 針板 Needle Plate

針孔寬度  
Needle Hole Width:  
6.9mm

## 210518 送布齒 Feed Dog

齒面寬度  
Teeth Width:  
13.3mm



## 210603 針板 Needle Plate

針孔寬度  
Needle Hole Width:  
6mm

## 210523 送布齒 Feed Dog

齒面寬度  
Teeth Width:  
13.5mm



## 210604 針板 Needle Plate

針孔尺寸  
Needle Hole Size:  
3mm x 1.2mm

## 210524 送布齒 Feed Dog

齒面寬度  
Teeth Width:  
10.5mm



## 503733N 針板 Needle Plate

針孔寬度  
Needle Hole Width:  
6mm

## 503734N 送布齒 Feed Dog

齒面寬度  
Teeth Width:  
13.5mm



**22186** 針板  
Needle Plate  
(連22186-3F 3針刷仔)  
(with 22186-3F 3 needle supporting  
finger)

**22186-2M** (2mm)  
雙針刷仔  
2 Needle Supporting Finger

**22186-3M** (3mm)  
雙針刷仔  
2 Needle Supporting Finger

**417921** 送布齒  
Feed Dog



## 503605 針板 Needle Plate

針孔寬度  
Needle Hole Width:  
10mm

## 541647 送布齒 Feed Dog

齒面寬度  
Teeth Width:  
17.5mm

鑽石紋  
Diamond Cut



**51768-L** 針板  
Needle Plate

針孔寬度  
Needle Hole Width:  
10.3mm

**417920-L** 送布齒  
Feed Dog

齒面寬度  
Teeth Width:  
17.5mm

中排齒排列  
Teeth number of Mid-row:  
5T + 8T



**51768-S** 針板  
Needle Plate

針孔寬度  
Needle Hole Width:  
10.3mm

**417920-S** 送布齒  
Feed Dog

齒面寬度  
Teeth Width:  
17.5mm

中排齒排列  
Teeth number of Mid-row:  
6T + 9T



**51768-SN** 針板  
Needle Plate

針孔寬度  
Needle Hole Width:  
10.3mm

**417920-SN** 送布齒  
Feed Dog

齒面寬度  
Teeth Width:  
17.5mm

中排齒排列  
Teeth number of Mid-row:  
6T + 9T



**225-81409S** 針板  
Needle Plate

針孔寬度  
Needle Hole Width:  
10.5mm

**225-81508S** 送布齒  
Feed Dog

齒面寬度  
Teeth Width:  
18mm

For JUKI LZ-2280 Zigzag Machine  
重機LZ-2280人字車適用



**225-48010** 針板  
Needle Plate

針孔寬度  
Needle Hole Width:  
6mm

**225-48119** 送布齒  
Feed Dog

齒面寬度  
Teeth Width:  
13.5mm

For JUKI LZ-2280 Zigzag Machine  
重機LZ-2280人字車適用

**K** 導傍及高低壓腳  
*Guiding & Compensating Feet*



**107-4L**

壓腳寬度  
Presser Foot Width:  
18mm



**107-5L**

壓腳寬度  
Presser Foot Width:  
13.3mm



### 107-6L

壓腳寬度  
Presser Foot Width:  
11.6mm



### 107-CL

左高低壓腳  
Left Compensating Foot



### 107-DL

兩級左高低壓腳  
2 Step Left Compensating  
Foot



### 107-DR

兩級右高低壓腳  
2 Step Right Compensating  
Foot



### 107SGL

左傍壓腳  
Left Compensating Guide



### 107SGR

右傍壓腳  
Right Compensating Guide



### 457-CL

左傍壓腳  
Left Compensating Guide



### 457-CR

右傍壓腳  
Right Compensating Guide





**266125**  
左右高低互補  
Moving Compensating

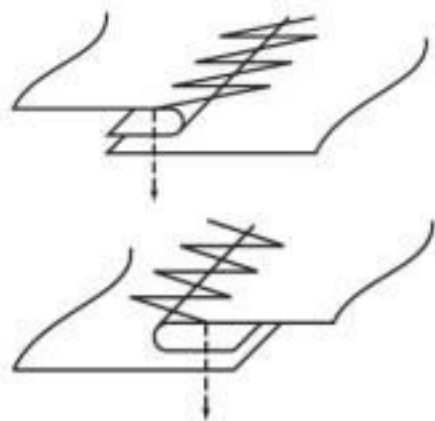

**266125M**  
左右高低互補  
Moving Compensating

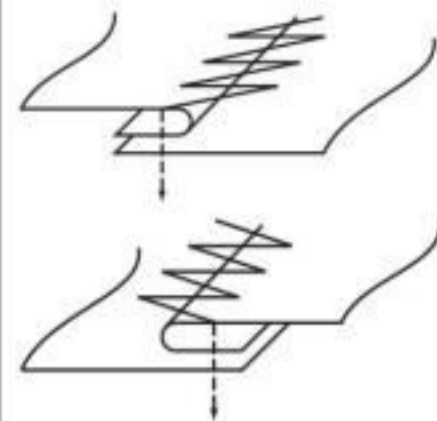

**266125K**  
左右高低互補  
Moving Compensating

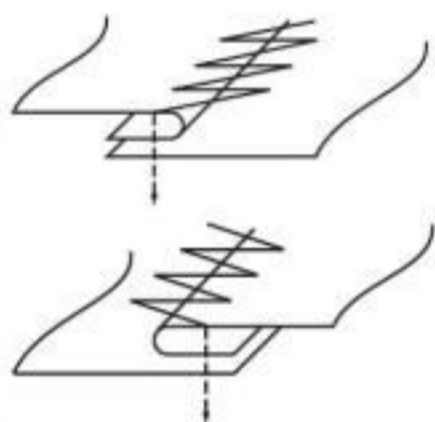

**3706**  
左高低互補  
Left Moving Compensating

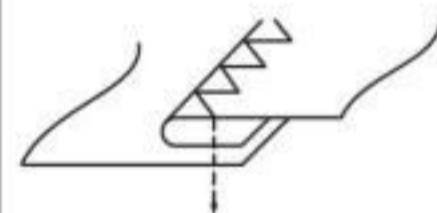

**3706K**  
左高低互補  
Left Moving Compensating

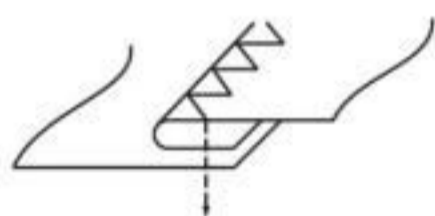

**3707**  
右高低互補  
Right Moving Compensating

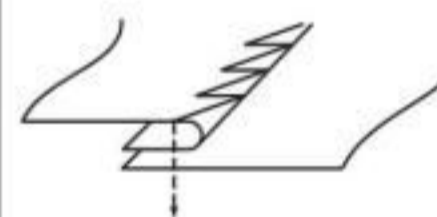

**3707K**  
右高低互補  
Right Moving Compensating

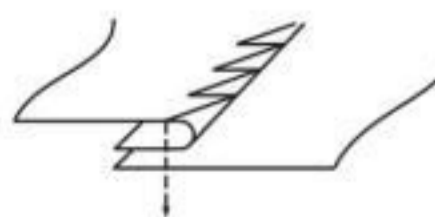

**23768 (107K)**  
開式縫用  
Center Guide for Open Seam

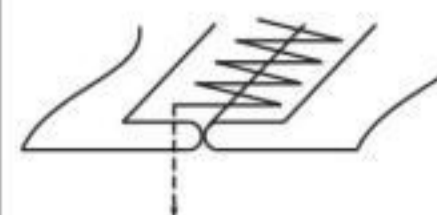



## GB107

傍位  
Edge Guide

# K 綑條及鬆緊帶 Tape & Elastic



## 107-029

最大綑條尺寸  
Max. Tape Size:  
34mm



## 107-029K

附中央導向片面貼壓腳  
Tape Attaching with Center  
Guide

可調校綑條尺寸  
Adjustable Tape Size:  
0 ~ 20mm



## 107-030

附滾輪面貼壓腳  
Tape Attaching with Roller  
Guide

可調校綑條尺寸  
Adjustable Tape Size:  
0 ~ 8mm

針孔寬度  
Needle Hole Wide:  
7mm



## 107-G5L

鬆緊帶尺寸  
Elastic Tape Size:  
7 ~ 17mm



## 23766A (457GB)

可調校鬆緊帶尺寸  
Adjustable Elastic Tape Size:  
5 ~ 18mm



## 23769

可調校鬆緊帶尺寸  
Adjustable Elastic Tape Size:  
7 ~ 20mm



## 23770

面貼壓腳  
Zigzag Tape Attaching Foot



Tape Size 入口	Finished Size 出口
5/8"	5/16"



## 23770K

開式縫面貼壓腳  
Zigzag Open Seam Tape Attaching Foot

(附中央導向片)  
(with Center Guide)



Tape Size 入口	Finished Size 出口
5/8"	5/16"



## 23771 (107C)

鬆緊帶尺寸  
Elastic Tape Size:  
7.4 ~ 21.5mm

壓腳寬度  
Foot Width:  
11mm



## 23771R

鬆緊帶尺寸  
Elastic Tape Size:  
7.4 ~ 21.5mm

壓腳寬度  
Foot Width:  
11mm



## 23771S

人字縫導邊壓腳(窄)  
Zigzag Guiding Presser  
Foot (Narrow)



## R23771

滾輪壓腳  
Roller Feet

最大鬆緊帶尺寸  
Max. Elastic Tape Size:  
20mm



## 23772 (107E)

彈性花邊面貼用  
For Elastic Tape or Lace

最大鬆緊帶尺寸  
Max. Elastic Tape Size:  
16mm

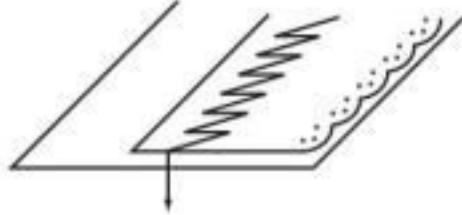
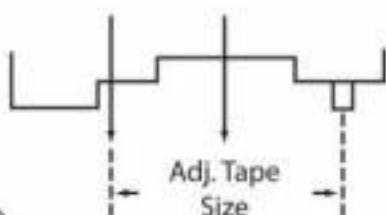

## 23779 (457A)

鬆緊帶尺寸  
Elastic Tape Size:  
4 ~ 15mm



## 23779A

交疊縫合  
For Cross Joint

鬆緊帶尺寸  
Elastic Tape Size:  
4 ~ 15mm

針孔寬度  
Needle Hole Width:  
10mm



## 23779R

附滾輪面貼壓腳  
Tape attaching with Roller  
Guide

鬆緊帶尺寸  
Elastic Tape Size:  
4 ~ 15mm

針孔寬度  
Needle Hole Width:  
10mm



## 23780 (457A1)

附導帶坑面貼壓腳  
Grooved Tape Attaching  
Foot

鬆緊帶尺寸  
Elastic Tape Size:  
5 ~ 14mm



## 23781

鬆緊帶尺寸  
Elastic Tape Size:  
7.4 ~ 21.5mm

壓腳寬度  
Foot Width:  
11mm

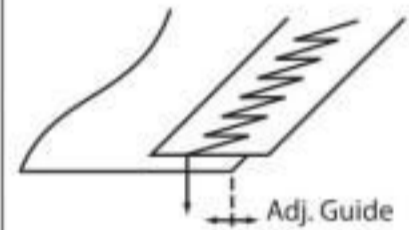

## 23782

壓腳連導片  
Presser Feet with Adjust-  
able Guide

## 23782-G

調節式導片  
Adjustable Guide



## 23870

可調校細條尺寸  
Adjustable Tape Size:  
10~ 13mm

針孔尺寸  
Needle Hole Size:  
10 x 1.5mm

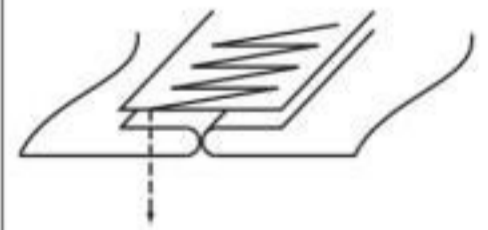

## 23425

鬆緊帶面貼壓腳  
Elastic Shirring Foot

鬆緊帶入口尺寸  
Elastic Tape Size:  
1/8", 3/16", 1/4", 3/8", 1/2"



## 603766

調節式三層面貼壓腳  
Adjustable 3 Layers Tape  
Attaching Foot

(鬆緊帶可用)  
(Applicable for Elastic Tape)

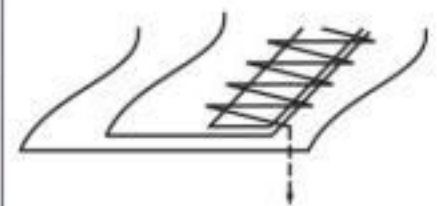



## B109

重機LZ-2280人字車適用  
For JUKI LZ-2280 Zigzag Machine

# K 包邊及摺邊 Binding & Hemming



## KHF36A

人字縫包邊器  
Edge Binder for Zigzag  
(薄身皮革及塑膠材料用)  
(For Thin Leather and Plastic Material)

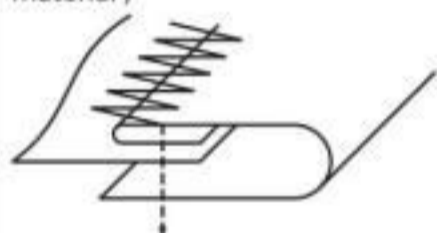

Tape Size 入口	1/2"	9/16"	3/4"
Finished Size 出口	3/16"	3/16"	1/4"



## KHF36B

人字縫包邊器  
Edge Binder for Zigzag  
(薄身皮革及塑膠材料用)  
(For Thin Leather and Plastic Material)



Tape Size 入口	1"	3/4"
Finished Size 出口	1/4"	3/16"



## KHF36C

人字縫包邊器  
Edge Binder for Zigzag  
(薄身皮革及塑膠材料用)  
(For Thin Leather and Plastic Material)

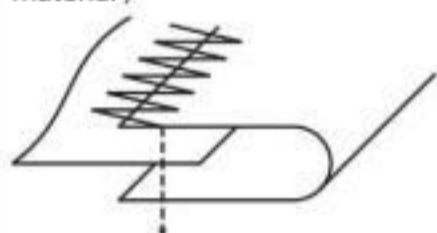

Tape Size 入口	1/2"	14mm	5/8"
Finished Size 出口	1/4"	7mm	5/16"



## KHF47

調節式上摺摺邊器  
Adjustable Upturn Hemmer for Zigzag  
(摺疊尺寸可調較)  
(Folding Size is Adjustable)

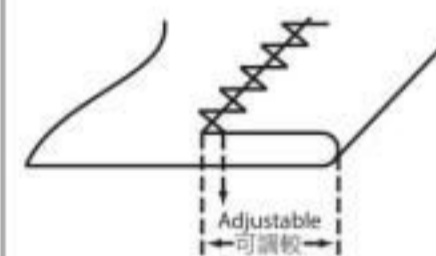

## KHF59A

人字縫包邊器  
Edge Binder for Zigzag

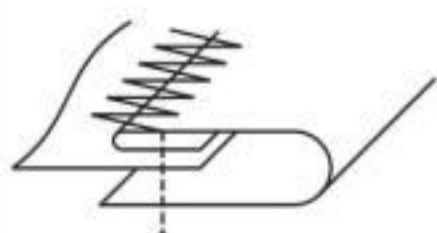

Tape Size 入口	1/2"	3/4"
Finished Size 出口	3/16"	1/4"



## KHF59B

人字縫包邊器  
Edge Binder for Zigzag

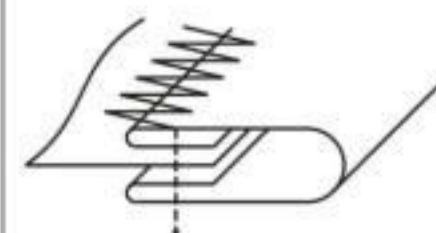

Tape Size 入口	1"	3/4"
Finished Size 出口	1/4"	3/16"

**KHF59C**  
 人字縫包邊器  
 Edge Binder for Zigzag



Tape Size 入口	1/2"	14mm	5/8"
Finished Size 出口	1/4"	7mm	5/16"

**KHF76**  
 胸罩包邊器  
 Brassiere Edge Binder

出口  
 Finished Size:  
 5.2mm, 6.4mm, 8mm



**KHF79**  
 胸罩包邊器  
 Brassiere Edge Binder



**S107H**  
 摺邊  
 Hemming:  
 2.5mm, 3mm, 4mm



**210569A**  
 壓腳寬度  
 Presser Foot Width:  
 13mm



**210569B**  
 壓腳寬度  
 Presser Foot Width:  
 13mm



**210562A-2** 壓腳  
 Presser Foot

壓腳寬度  
 Presser Foot Width:  
 14.5mm

**210524S** 送布齒  
 Feed Dog

齒面寬度  
 Teeth Width:  
 10mm

**210604S** 針板  
 Needle Plate



**210562A-3** 壓腳  
Presser Foot

壓腳寬度  
Presser Foot Width:  
14.5mm

**210516A-3** 送布齒  
Feed Dog

齒面寬度  
Teeth Width:  
10mm

**210596A-3** 針板  
Needle Plate



**210562A-4** 壓腳  
Presser Foot

壓腳寬度  
Presser Foot Width:  
16mm

**210516A-4** 送布齒  
Feed Dog

齒面寬度  
Teeth Width:  
14mm

**210596A-4** 針板  
Needle Plate



**210562A-5** 壓腳  
Presser Foot

壓腳寬度  
Presser Foot Width:  
18mm

**210516A-5** 送布齒  
Feed Dog

齒面寬度  
Teeth Width:  
17.5mm

**210596A-5** 針板  
Needle Plate

特厚針板 Extra Thick Needle Plate

包邊器連針位  
Binder & Gauge Set (KHF59)



Tape Size 入口 1/2" 3/4"  
Finished Size 出口 3/16" 1/4"

Tape Size 入口 1" 3/4"  
Finished Size 出口 1/4" 3/16"

Tape Size 入口 1/2" 14mm 5/8"  
Finished Size 出口 1/4" 7mm 5/16"

Select one of the following Gauge Sets 選配以下其中一套針位

Presser Foot 壓腳

Feed Dog 送布齒

Needle Plate 針板

**210562A-3**

**210516A-3**

**210596A-3**

**210562A-4**

**210516A-4**

**210596A-4**

**210562A-5**

**210516A-5**

**210596A-5**

**包邊器連針位 (KHF76)**  
Binder & Gauge Set



**KHF76**

胸罩包邊器  
Brassiere Edge Binder

出口  
Finished Size:  
5.2mm, 6.4mm, 8mm

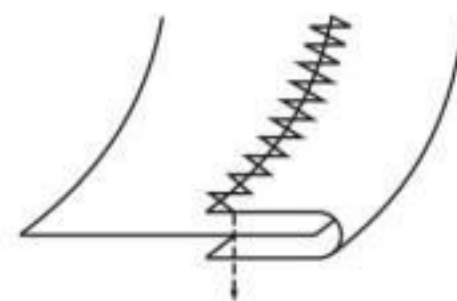

Select one of the following Gauge Sets 選配以下其中一套針位

Presser Foot 壓腳	Feed Dog 送布齒	Needle Plate 針板
210562A-3	210516A-3	210596A-3
210562A-4	210516A-4	210596A-4
210562A-5	210516A-5	210596A-5

**K** 人字縫擺針凸輪  
Zigzag Needle  
Vibrating Cam



**411146** (502969)

人字凸輪  
Zigzag Cam

Stitch Pattern 線跡模樣



Max Pattern Width 最大模樣寬度 ---

Max Stitch Width 最大擺動距離 ---



**411394** (551893)

兩點人字凸輪  
Plain Zigzag Cam

Stitch Pattern 線跡模樣



Max Pattern Width 最大模樣寬度 5mm

Max Stitch Width 最大擺動距離 ---



**411462** (551895)

三點人字凸輪  
2-Step Zigzag Cam

Stitch Pattern 線跡模樣



Max Pattern Width 最大模樣寬度 8mm

Max Stitch Width 最大擺動距離 ---



**411362** (551897)

四點人字凸輪  
3-Step Zigzag Cam

Stitch Pattern 線跡模樣



Max Pattern Width 最大模樣寬度 8mm

Max Stitch Width 最大擺動距離 ---



**411295** (551899)

均寬扇狀凸輪(24針)  
Even Width Scallop Cam  
(24 Stitch)

Stitch Pattern 線跡模樣



(A) Max Pattern Width 最大模樣寬度 8mm

(B) Max Stitch Width 最大擺動距離 2.6mm





**411360** (551901)

新月扇狀凸輪  
Crescent Scallop Cam

Stitch Pattern 線跡模樣



(A) Max Pattern Width最大模樣寬度 8mm  
(B) Max Stitch Width最大擺動距離 3.6mm



**411464** (551903)

均寬扇狀凸輪(24針)  
Even Width Scallop Cam  
(24 Stitch)

Stitch Pattern 線跡模樣



(A) Max Pattern Width最大模樣寬度 8mm  
(B) Max Stitch Width最大擺動距離 3.4mm

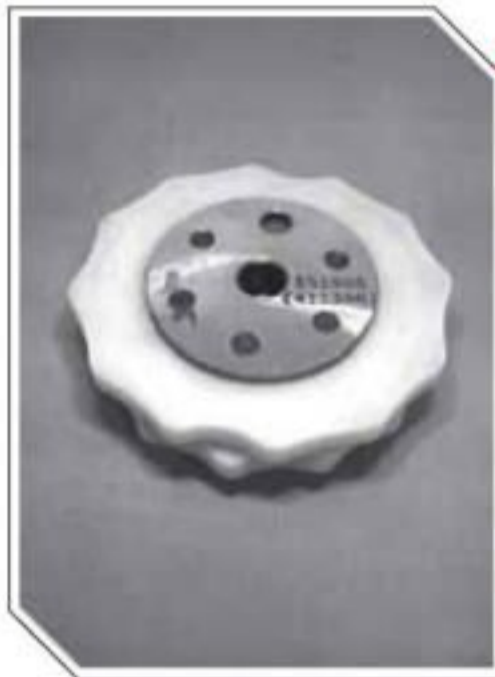

**411358** (551905)

簡單扇狀凸輪  
Rough Scallop Cam

Stitch Pattern 線跡模樣

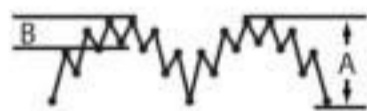

(A) Max Pattern Width最大模樣寬度 8mm  
(B) Max Stitch Width最大擺動距離 2.4mm



**411396** (551907)

4針暗縫凸輪  
Blind Stitch Cam (4-Stitch)

Stitch Pattern 線跡模樣



Max Pattern Width最大模樣寬度 5mm  
Max Stitch Width最大擺動距離 —



**411364** (551909)

6針暗縫凸輪  
Blind Stitch Cam (6-Stitch)

Stitch Pattern 線跡模樣



Max Pattern Width最大模樣寬度 5mm  
Max Stitch Width最大擺動距離 —



**411480** (551911)

8針暗縫凸輪  
Blind Stitch Cam (8-Stitch)

Stitch Pattern 線跡模樣



Max Pattern Width最大模樣寬度 5mm  
Max Stitch Width最大擺動距離 —



**411482** (551913)

12針暗縫凸輪  
Blind Stitch Cam (12-Stitch)

Stitch Pattern 線跡模樣



Max Pattern Width最大模樣寬度 5mm  
Max Stitch Width最大擺動距離 —



**411195**

魚網狀高速人字車用凸輪  
Fishing Net Cam for High  
Speed Zigzag Machine

Stitch Pattern 線跡模樣



For 457A-104-M Fagoting Zigzag Machine  
457A-104-M抽紗人字車適用

(A) Max Pattern Width最大模樣寬度 8mm  
(B) Max Stitch Width最大擺動距離 6.5mm



## 411196

魚網狀高速人字車用凸輪  
Fishing Net Cam for High Speed Zigzag Machine

Stitch Pattern 線跡模樣

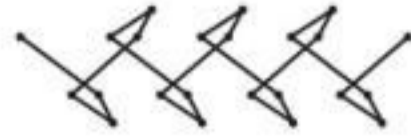

For 457A-104-M Fagoting Zigzag Machine  
457A-104-M抽紗人字車適用

(A) Max Pattern Width最大模樣寬度 8mm  
(B) Max Stitch Width最大擺動距離 6.5mm

# K 透明塑膠壓腳 Transparent Plastic Presser Feet



## PT-107

全鋼壓腳頭  
Steel Presser Feet Head



## T-086

壓腳寬度  
Presser Foot Width:  
11.5mm  
針孔尺寸  
Needle Hole Size:  
6mm x 1.5mm



## T-254

壓腳寬度  
Presser Foot Width:  
15mm  
針孔尺寸  
Needle Hole Size:  
8mm x 1.5mm



## T-314

壓腳寬度  
Presser Foot Width:  
19mm  
針孔尺寸  
Needle Hole Size:  
11.5mm x 2mm



## TL-107

左傍邊壓腳  
Left Edge Guiding  
傍位與針孔間之距離  
Distance between Guide &  
Needle Hole:  
0mm  
針孔尺寸  
Needle Hole Size:  
7mm x 1.5mm



## TL-457

左傍邊壓腳  
Left Edge Guiding  
傍位與針孔間之距離  
Distance between Guide &  
Needle Hole:  
0mm  
針孔尺寸  
Needle Hole Size:  
11.5mm x 2mm

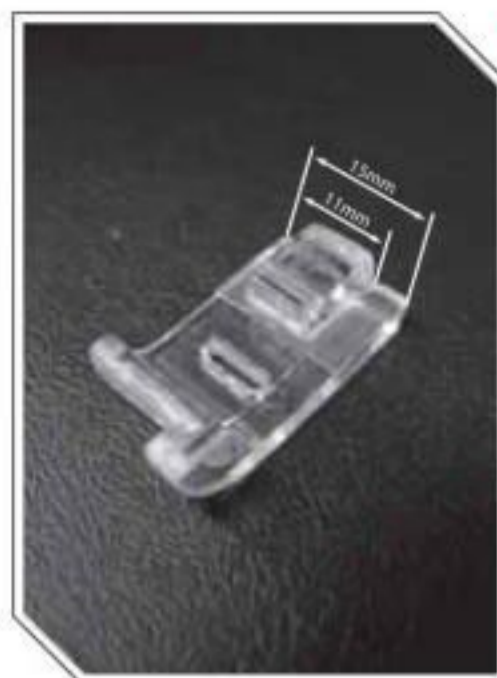

### TR-107

右傍邊壓腳  
Right Edge Guiding

傍位與針孔間之距離  
Distance between Guide &  
Needle Hole:  
0mm

針孔尺寸  
Needle Hole Size:  
7mm x 1.5mm

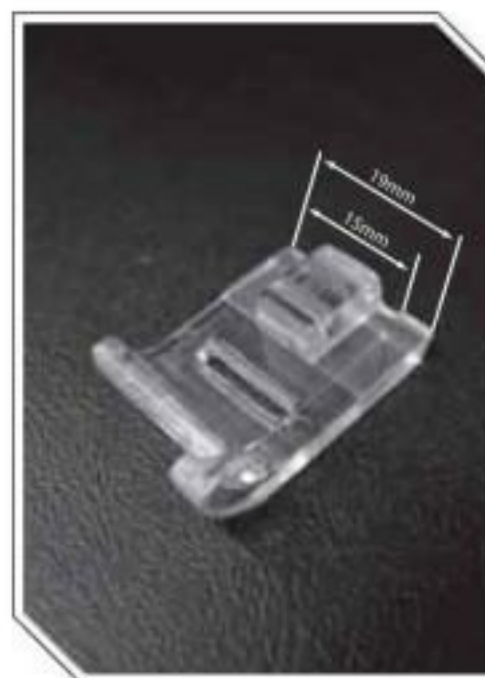

### TR-457

右傍邊壓腳  
Right Edge Guiding

傍位與針孔間之距離  
Distance between Guide &  
Needle Hole:  
0mm

針孔尺寸  
Needle Hole Size:  
11.5mm x 2mm

## K 接合縫及底綑條 Butting Seam & Undertape



22185 針板  
Needle Plate

22223 送布齒  
Feed Dog

(胸罩杯狀接合縫用)  
(For Butting Seam of Brassiere)



22187 針板  
Needle Plate

(可調較底綑條尺寸)  
(Under-tape Size Adjustable)

22223 送布齒  
Feed Dog

(胸罩杯狀接合縫用)  
(For Butting Seam of Brassiere)



KHF457

底綑條拉帶器  
Undertape Folder

可用配件  
Other Applicable Parts:  
Needle Plate 針板 22185  
Needle Plate 針板 22187

## K 特別應用人字縫零件 Zigzag Parts for Special Application



235-12551

胸罩勾扣用  
For Hooks & Eye of  
Brassiere

# K 百福人字縫 PFAFF Zigzag



**R438**  
人字縫滾輪壓腳  
Roller Zigzag Feet



**R438CK**  
人字縫滾輪導傍壓腳  
Roller Zigzag Feet with Guiding



**438GA**  
附導帶坑導傍壓腳  
Guiding Feet with Groove



**438GA-1**  
附導帶坑導傍壓腳  
Guiding Feet with Groove



**91-052021-93**  
摺邊  
Hemming:  
2.5mm, 3mm, 4mm



**438C**  
導傍壓腳  
Guiding Feet

# K 胸罩杯及鋼線助縫設備

## Attachment for Bra Cup & Underwire



### KHF68

胸罩胸杯部份接縫及襯裡貼邊  
Lining Tape Attaching  
Folder for Cup Sewing

針距  
Needle Space:  
1/8", 3/16", 1/4", 5/16", 3/8"

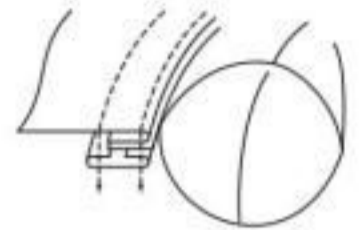

雙針 DOUBLE NEEDLES



### KHF71

胸罩鋼線包縫器  
Bra Underwire Support  
Attachment

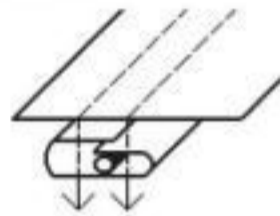

針距 Needle Space	入口 Tape Size	出口 Finished Size
1/4"	1-1/8"	3/8"
1/4"	1"	3/8"
3/16"	15/16"	5/16"
1/8"	3/4"	1/4"



### KHF77

上下細條包鋼線貼邊器  
Two-piece Bra Underwire  
Support Attachment

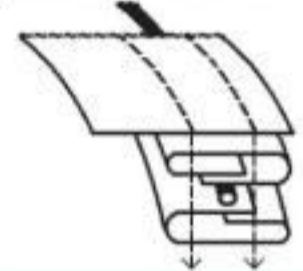

針距 Needle Space	入口 Tape Size	出口 Finished Size
1/4"	1"	3/8"



### KHF78A

包鋼線貼邊器  
Bra Underwire Support  
Attachment

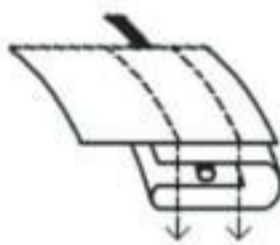

針距 Needle Space	入口 Tape Size	出口 Finished Size
1/4"	1-1/8"	3/8"



### KHF78B

包鋼線貼邊器  
Bra Underwire Support  
Attachment

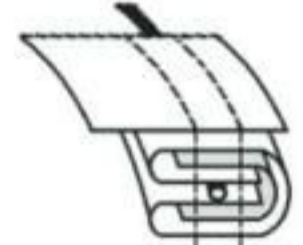

針距 Needle Space	襯裡 Lining	入口 Tape Size	出口 Finished Size
1/4"	3/4"	1-1/2"	3/8"



### KHF92

胸罩鋼線包縫  
Bra Underwire Support  
Attachment

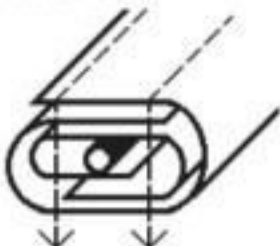

KHF92	S	L
Outer Tape Size 外帶尺寸	22mm	25mm
Inner Tape Size 內帶尺寸	20mm	23mm
Finished Size 出口	8mm	10mm
Needle Space 針距	1/4"	5/16"



### KHF97

三重捲包硬片面貼器  
Triple Folded Brassiere  
Strip Support Attachment

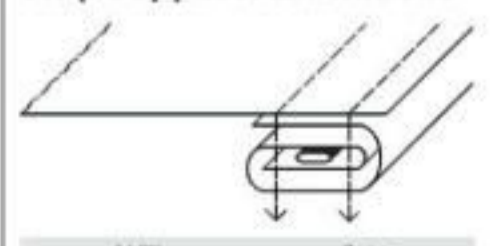

針距 Needle Space	入口 Tape Size
3/16"	30mm
1/4"	40mm



### KHF99

包鋼線貼邊器(直角曲咀)  
Bra Underwire Support  
Attachment (Right Angle)



針距 Needle Space	入口 Tape Size	出口 Finished Size
3/16"	1-1/4"	5/16"
1/4"	1-1/2"	3/8"

# K 面貼綑條-助縫設備 Tape Attaching - Attachment



### KHF38

袖圈貼邊器  
Sleeve Facing Folder

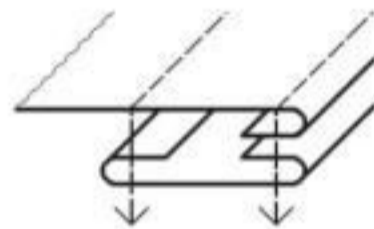

針距 Needle Space	出口 Finished Size
1/4"	3/8"



### KHF63

綑條貼邊器(胸罩及內褲用)  
Lining Tape Attaching  
Folder for Bra / Lingerie

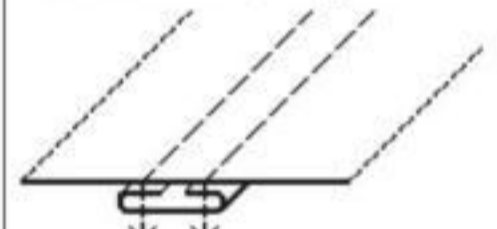

Needle Space 針距			
1/8"	3/16"	7/32"	1/4"
5/16"	3/8"	7/16"	1/2"



### KHF81

可調式花邊貼邊器  
Adjustable Lace Attaching  
Folder

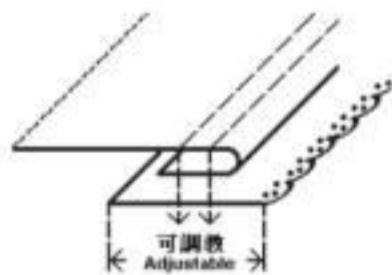

### KHF96

胸罩用包硬片面貼器  
Bra Strip Support Attachment

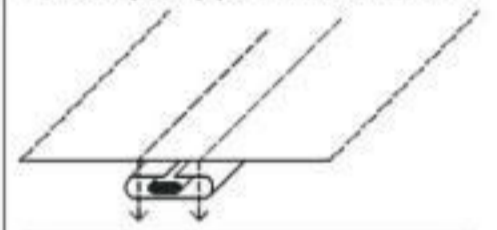

Needle Space 針距
1/4"

### 212-96

硬片導坑壓腳  
Grooved Presser Foot for Strip



### 212-684

懸掛式導帶器  
Suspending Tape Attach-  
ment

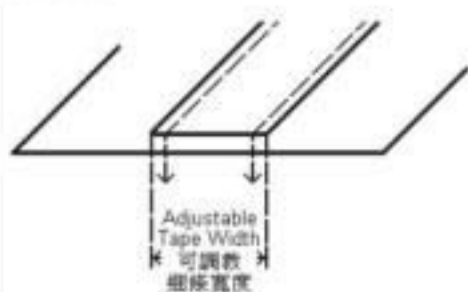

### 24711

懸掛式面貼器  
Suspended Tape Folder

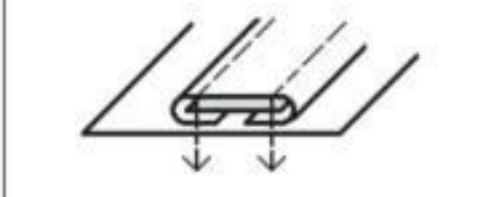

針距 Needle Space	入口 Tape Size
3.2mm	15mm
4.8mm	18mm
6.4mm	23mm

## 21139 胸罩用導帶器 Strip Guide for Brassieres

**21139A**

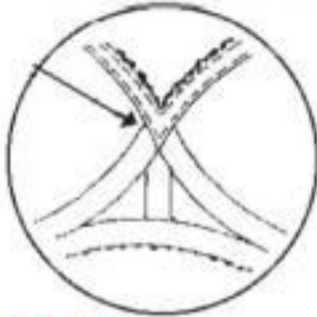

**KHF71**

胸罩鋼線包縫器  
Bra Underwire Support Attachment



**21139B**

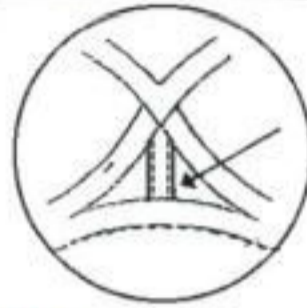

**K41B**

雙針車推板  
Slide Plate for Double Needle Machine



**21139C**

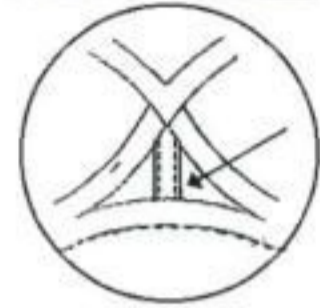

21139A或21139B配合K41B及KHF71一併使用  
Fit 21139A or 21139B to K41B Slide Plate and KHF71 Folder

雙針 DOUBLE NEEDLES

**21140**

胸圍鋼圈導帶器  
Strip Guide with Cover Plate

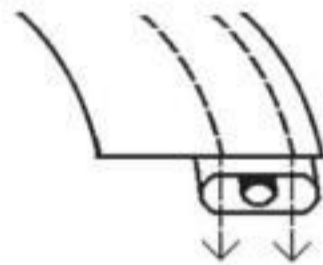

Stripe Size 帶子尺寸

9mm 10mm 12mm

**K**面貼網條一壓腳  
Tape Attaching  
- Attaching Feet

**212-005A**

可調較面貼網條雙針壓腳  
Double Needle Adjustable  
Tape Attaching Foot

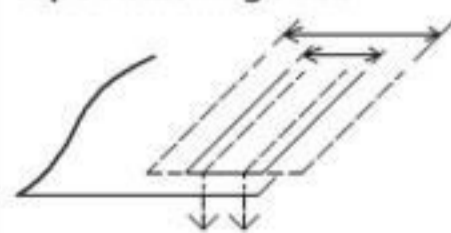

針距 Needle Space	入口 Tape Size
3.2mm	5.5mm ~ 22mm
4.8mm	6.5mm ~ 22mm
6.4mm	7.8mm ~ 22mm

**212-112**

可調較面貼網條雙針壓腳  
Double Needle Adjustable  
Tape Attaching Foot

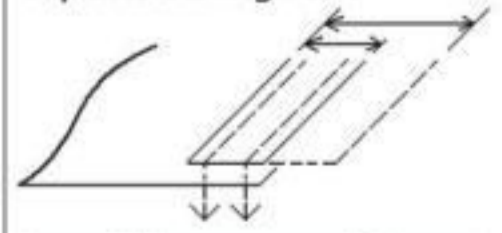

針距 Needle Space	入口 Tape Size
4.8mm	6.5mm ~ 11.2mm
6.4mm	8mm ~ 16.6mm



## 23061

面貼細條壓腳  
Tape Attaching Foot

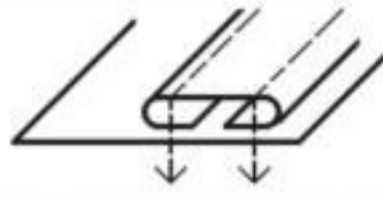

針距 Needle Space	入口 Tape Size	出口 Finished Size
3/16"	5/8"	5/16"
3/16"	3/4"	5/16" Overlapped搭口
1/4"	3/4"	3/8"
1/4"	7/8"	3/8" Overlapped搭口



## 23071

面貼細條壓腳  
Open Seam Tape Attaching Foot

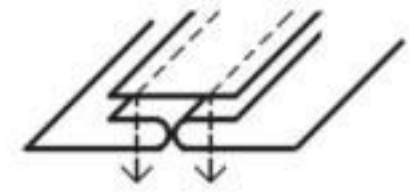

Needle Space 針距		
1/8"	3/16"	7/32"
1/4"		



## 23072

調節式面貼細條壓腳  
Adjustable Tape Attaching Feet

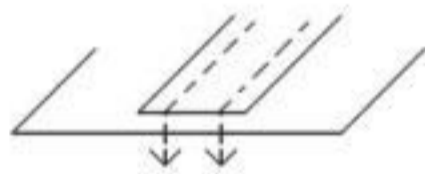

針距 Needle Space	可調節細條寬度 Adjustable Tape Size
1/4"	8.5mm - 16mm



## 23073

開式縫面貼細條壓腳  
Open Seam Tape Attaching Foot

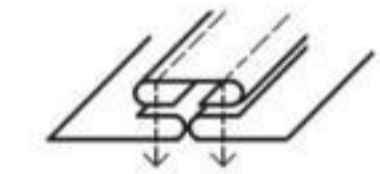

針距 Needle Space	入口 Tape Size	出口 Finished Size
3/16"	5/8"	5/16"
1/4"	3/4"	3/8"



## 23207

開式縫面貼細條壓腳  
Open Seam Tape Attaching Foot

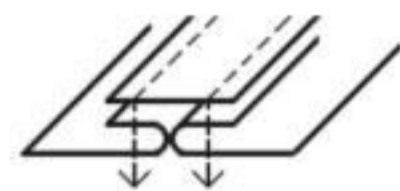

針距 Needle Space		
1/8"	3/16"	1/4"

# K 面貼細條一針位 Tape Attaching - Gauge Set

## 21010 胸罩面貼用針位 Gauge Set for Brassiere Tape Attaching



### 21010-1

右傍壓腳  
Presser Feet with Right Compensating Guide

### 21010-2

導帶坑針板  
Undercut Needle Plate

### 21010-3

送布齒  
Feed Dog

Needle Space 針距	1/8"	3/16"	7/32"	1/4"



**21010A** 胸罩面貼用針位  
Gauge Set for Brassiere Tape Attaching



**21010-1AL**

左傍壓腳  
Presser Feet with Left Edge Guide

**21010-1AR**

右傍壓腳  
Presser Feet with Right Edge Guide

**21010-2**

導帶坑針板  
Undercut Needle Plate

**21010-3A**

高低導帶送布齒  
Compensating Feed Dog with Extra  
Tape Guide

針距 Needle Space	綑條出口 Finished Size
3/16"	5/16"
7/32"	11/32"
1/4"	3/8"

雙針 DOUBLE NEEDLES

**彎形面貼針位**  
Gauge Set for Curved Tape Attaching



**S570AL**

附左傍右向彎形坑壓腳  
Right Curved Grooved Feet with Left  
Compensating Guide

針距 Needle Space	
3/16"	1/4"

**S570AR**

附右傍左向彎形坑壓腳  
Left Curved Grooved Feet with Right  
Compensating Guide

針距 Needle Space	
3/16"	1/4"

**223884H**

彎形導帶坑針板  
Curved Undercut Needle Plate

**223628H**

特高送布齒  
Feed Dog (Extra High)

針距 Needle Space	
3/16"	1/4"

**21014** 胸罩彎形硬條針位  
Gauge Set for Brassiere Curved Underwire Support



**21014-1**

右向彎形坑壓腳  
Presser Feet Curvedly Grooved to Right

**21014-2**

加傍邊右彎導帶坑針板  
Undercut Needle Plate with Extra Guide

**21014-3**

送布齒  
Feed Dog

Needle Space 針距	3/16"	1/4"
-----------------	-------	------

**224053**

襯裡針板  
Needle Plate with Tape Insert

**224029** 送布齒  
Feed Dog

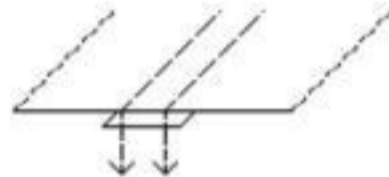

針距 Needle Space	最寬襯裡尺寸 Max Tape Size
4.8mm	8mm
6.4mm	10mm

**K** 包邊針位  
Binding Gauge Set

雙針 DOUBLE NEEDLES

包邊器連針位  
Binder & Gauge Set (KHF36)



入口 Tape Size	出口 Finished Size	入口 Tape Size	出口 Finished Size	入口 Tape Size	出口 Finished Size
1/2"	3/16"	1"	1/4"	1/2"	1/4"
9/16"	3/16"	3/4"	3/16"	14mm	7mm
1/4"	3/4"			5/8"	5/16"

**23067NP** Needle Plate 針板    **23067PF** Presser Foot 壓腳  
**23067FD** Feed Dog 送布齒    **112607SP** Slide Plate 推板

Size 尺寸	1/4"
---------	------

**K** 其他針位  
Other Gauge Set



**212-112K**

開式縫中央傍片壓腳  
Open Seam Guiding Foot

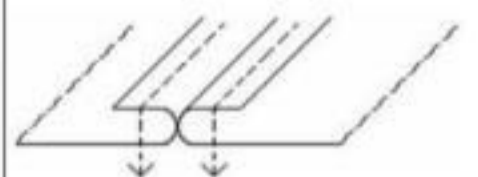

Needle Space 針距			
1/8"	3/16"	7/32"	1/4"
3/8"	1/2"	5/8"	



## 23069

配合可拆除式中央導向片  
(開式縫用)  
With Removable Center  
Guide for Open Seam

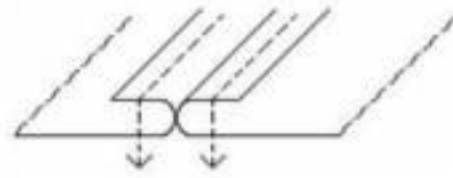

針距 Needle Space	
3/16"	1/4"



## 112W-C9

針距  
Needle Space:  
3/16", 1/4"



## 223773

傍邊壓腳  
Edge Guiding Foot

針距  
Needle Space:  
3.2mm, 4.8mm, 6.4mm



## 24873S

薄料用針板  
Needle Plate for Thin  
Material

針距 Needle Space	
3/16"	1/8"

可用配件  
Other Applicable Parts:  
Feed Dog 送布齒 21010-3

## 23388 固定針針位 Box Type Gauge Set



## 23388-4

壓腳  
Presser Feet

## 23388-5

固定針針板  
Box Type Needle Plate

## 23388-6

固定針送布齒  
Box Type Feed Dog

Needle Space 針距	1/8"	3/16"	1/4"

# **K** 鬆緊帶調節器 *Tension Device*



## **2280-T1**

滾輪式單層鬆緊帶調節器  
Roller Type Single Tension Device

(平均壓力分佈設計)  
(Even Pressure Design)



## **2280-T2**

滾輪式雙層鬆緊帶調節器  
Roller Type Double Tension Device

(平均壓力分佈設計)  
(Even Pressure Design)



## **KH457-T1**

單層鬆緊帶調節器  
Single Tension Device

(平均壓力分佈設計)  
(Even Pressure Design)



## **KH457-T2**

雙層鬆緊帶調節器  
Double Tension Device

(平均壓力分佈設計)  
(Even Pressure Design)



## **457-T1**

單層鬆緊帶調節器  
Single Tension Device



## **457-T2**

雙層鬆緊帶調節器  
Double Tension Device



## **457G-188**

鬆緊帶調節器  
Tension Device

其他 OTHERS



**831T**  
雙針車用鬆緊帶調節器  
Tension Device for Double  
Needle Machine

# K 其他配件 Other Parts



**KH373-75**  
胸罩飾花用夾模  
Clamp for Bra Corsage



**KH373-86**  
釘勾扣夾模  
Eye and Hook Clamp



**SP-18N**  
3mm單針右傍壓腳  
Single Needle Presser Foot  
with Right Compensating  
Guide (3mm)



**KHF83**  
繡縫車細條面貼器  
Tape Attach Folder for  
Covering Stitch

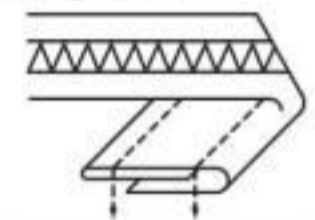

Tape Size 入口	Finished Size 出口
14mm	5.6mm
15mm	6.4mm
17mm	7.2mm
19mm	8.0mm
21mm	8.8mm

Assemble The Folder At The Front  
of Covering Stitch Presser Foot  
安裝於繡縫車壓腳前

其他 OTHERS



**K10**  
平車直角包縫器  
Right Angle Bias Binder

入口  
Tape Size:  
18mm, 20mm, 22mm, 24mm, 26mm, 28mm, 30mm, 32mm, 34mm, 36mm,  
38mm, 40mm, 42mm, 45mm, 50mm

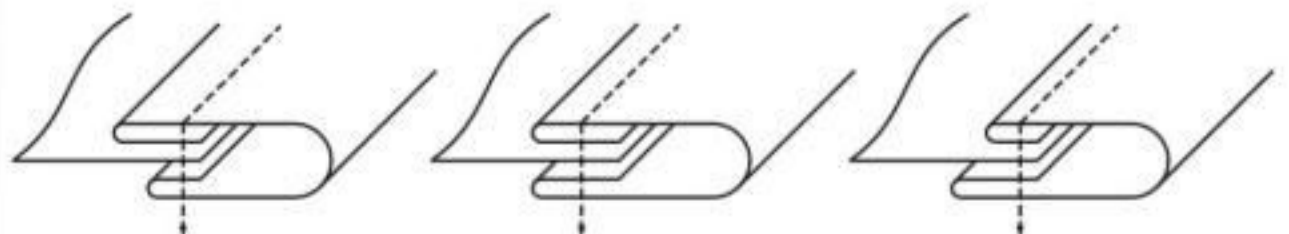

## 背扣針位 Gauge Set for Eye & Hook



**107-089**

壓腳  
Presser Feet

**210515**

送布齒  
Feed Dog

**210595**

有坑針板  
Grooved Needle Plate

## 繡縫車直角鬆緊包邊器 Right Angle Elastic Binder for Covering Stitch Machine

**KHF57**



**KHF62**



**AE**

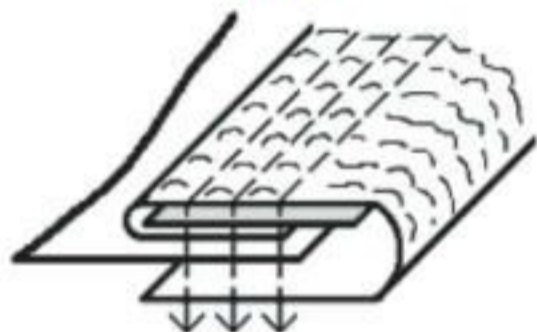

**BE**

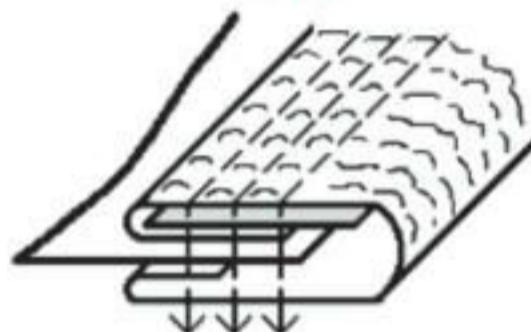

**CE**

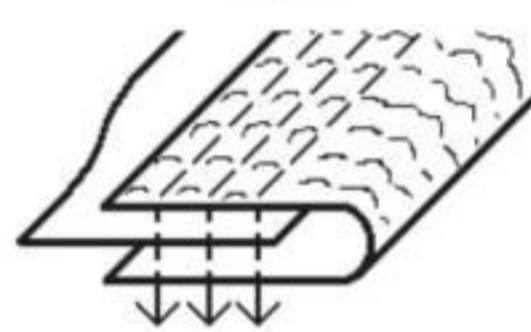

Tape Size 入口	Finished Size 出口
3/4"	1/4"
15/16"	5/16"
1-1/8"	3/8"
1-3/8"	1/2"
1-5/8"	5/8"
1-7/8"	3/4"
2-1/8"	7/8"
2-3/8"	1"
2-5/8"	1-1/8"
2-7/8"	1-1/4"
3-1/8"	1-3/8"
3-3/8"	1-1/2"

Tape Size 入口	Finished Size 出口
1"	1/4"
1-1/4"	5/16"
1-1/2"	3/8"
1-3/4"	1/2"
2"	5/8"
2-1/4"	3/4"
2-1/2"	7/8"
2-3/4"	1"
3"	1-1/8"
3-1/4"	1-1/4"
3-1/2"	1-3/8"
3-3/4"	1-3/8"

Tape Size 入口	Finished Size 出口
1/2"	1/4"
5/8"	5/16"
3/4"	3/8"
7/8"	7/16"
1"	1/2"

其他 OTHERS

Olympian  
奧林比安

# 送料器

## Tape Feeder

# TF-713 / TF-813

# TF-714 / TF-814

# TF-714U



## TF-713 / TF-813

側送型送料器  
Lateral Tape Feeder

Max Width 最大寬度: 50mm (TF-713) / 90mm (TF-813)

Roller 送料輪: 鋼齒輪及塑膠輪(各一對)  
Steel & Plastic Rollers  
(One Pair Each)

Power 電源: 8W  
110V ~ 220V

Packing Size 包裝尺寸: 45 x 29 x 27 cm

TF-713/TF-813送料器多用於直角包邊，置於縫紉機側面，由右至左將細條/布帶送至縫紉機及包邊器。每套送料器均附上鋼齒輪及膠輪各一對，以配合不同質料的細條及布帶。特設蜂鳴器，當送布輪遇上細條打結或不能順暢地送料時，便會發出警示並停止運作。TF-713採用50mm送料輪，適合一般通用的細條；而TF-813則採用90mm送料輪，較闊的細條合用。

It is mainly used for binding, mounted on the table at the right hand side of sewing machine and feeding the tape into the binder. Two sets of rollers, steel and plastic, are provided for different tapes. TF-713 is narrower, 50mm wide and TF-813 is wider, 90mm wide. Its anti-knotted device will alarm if the tape is knotted or can't be fed smoothly.



## TF-714 / TF-814

垂直型送料器  
Downward Tape Feeder

Max Width 最大寬度: 50mm (TF-714) / 90mm (TF-814)

Roller 送料輪: 鋼齒輪及塑膠輪(各一對)  
Steel & Plastic Rollers  
(One Pair Each)

Power 電源: 8W  
110V ~ 220V

Packing Size 包裝尺寸: 45 x 29 x 27 cm

TF-714/TF-814送料器多用於面貼或鬆緊帶，置於縫紉機之後，由上而下將細條/鬆緊帶送至縫紉機前。隨機附上鋼齒輪及膠輪各一對，以配合不同質料的細條及鬆緊帶。特設蜂鳴器，當送布輪遇上細條打結或不能順暢地送料時，便會發出警示並停止運作。TF-714採用50mm送料輪，適合一般通用的細條；而TF-814則採用90mm送料輪，較闊的細條合用。

It is mainly used for tape attaching, mounted behind the sewing machine and feeding material into the machine. Two sets of rollers, steel and plastic, are provided for different tapes. TF-714 is narrower, 50mm wide and TF-814 is wider, 90mm wide. Its anti-knotted device will alarm if the tape is knotted or can't be fed smoothly.



## TF-714U

垂直型送料器連防止打結裝置  
Downward Tape Feeder with Untangling Device

Max Width 最大寬度: 50mm

Roller 送料輪: 鋼齒輪及塑膠輪(各一對)  
Steel & Plastic Rollers  
(One Pair Each)

Power 電源: 8W  
110V ~ 220V

TF-714U結合了TF-714送料器及奧林比安防止打結裝置，用於面貼或鬆緊帶，置於縫紉機之後，由上而下將細條/鬆緊帶送至縫紉機前。隨機附上鋼齒輪及膠輪各一對，以配合不同質料的細條及鬆緊帶。防打結裝置與送料器連結，不停高速轉動可避免細條糾纏打結，保證送料器運作順利。另特設蜂鳴器，當送布輪遇上細條打結或不能順暢地送料時，便會發出警示並停止運作。

It is a combination of TF-714 tape feeder and Olympian Untangling Device. It is for tape or elastic which has been released and placed behind the sewing machine.

The Untangling Device is linked with the tape feed. It rotate simultaneously with the tape feeder to loosen the tape before it was inserted into the feeder. Its anti-knotted device will alarm if the tape is knotted or can't be fed smoothly.

# GD112 - TP 束腰內衣用壓腳 Presser Foot for Corset

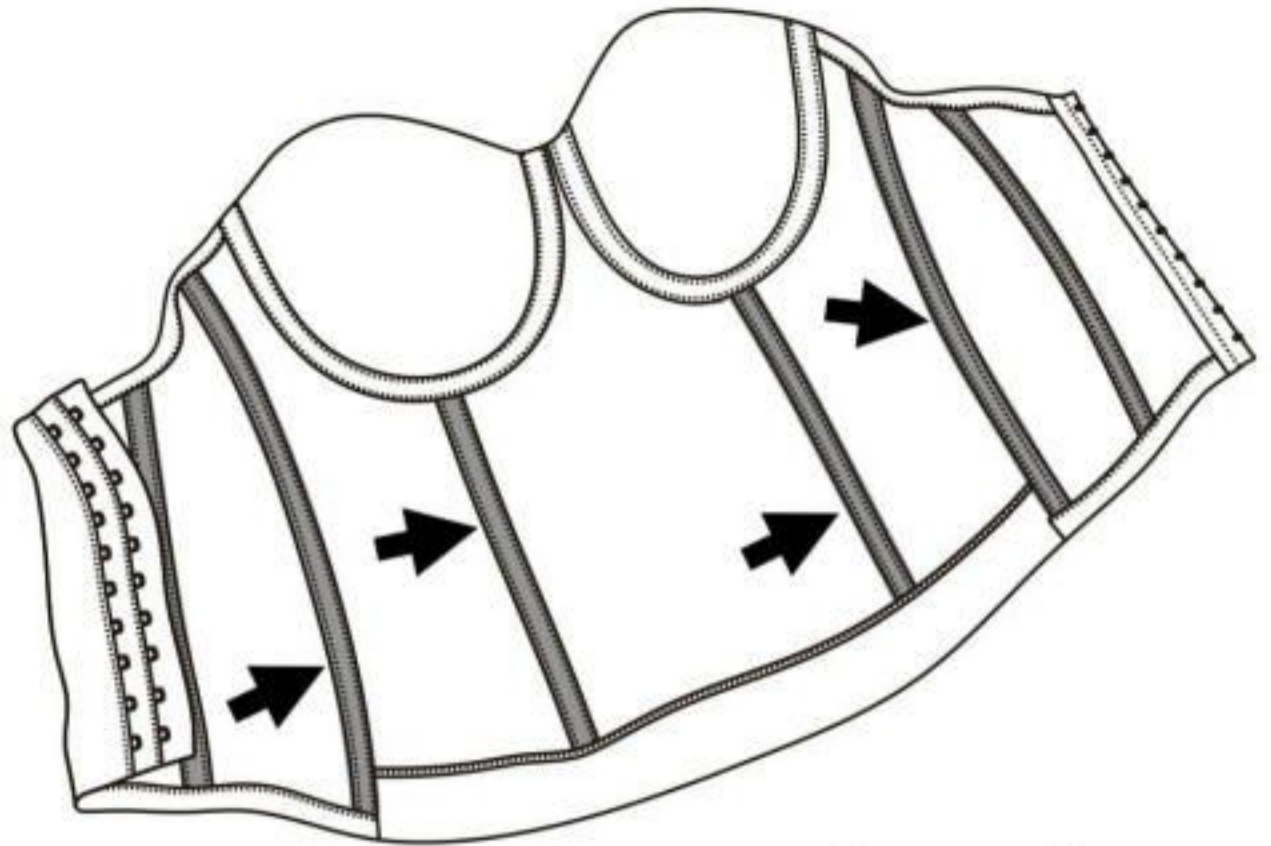

膠條  
Plastic  
Tape

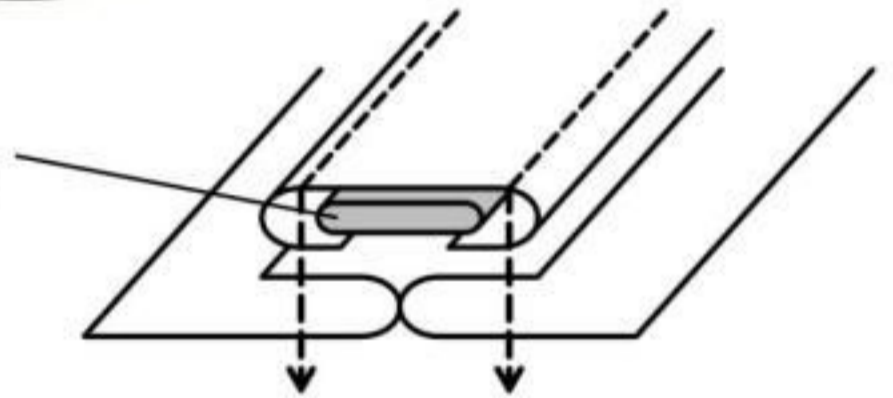

Tape folding patterns depend on the folder, which can be tailor-made.  
細條包縫款式取決於助縫器，  
歡迎訂造。

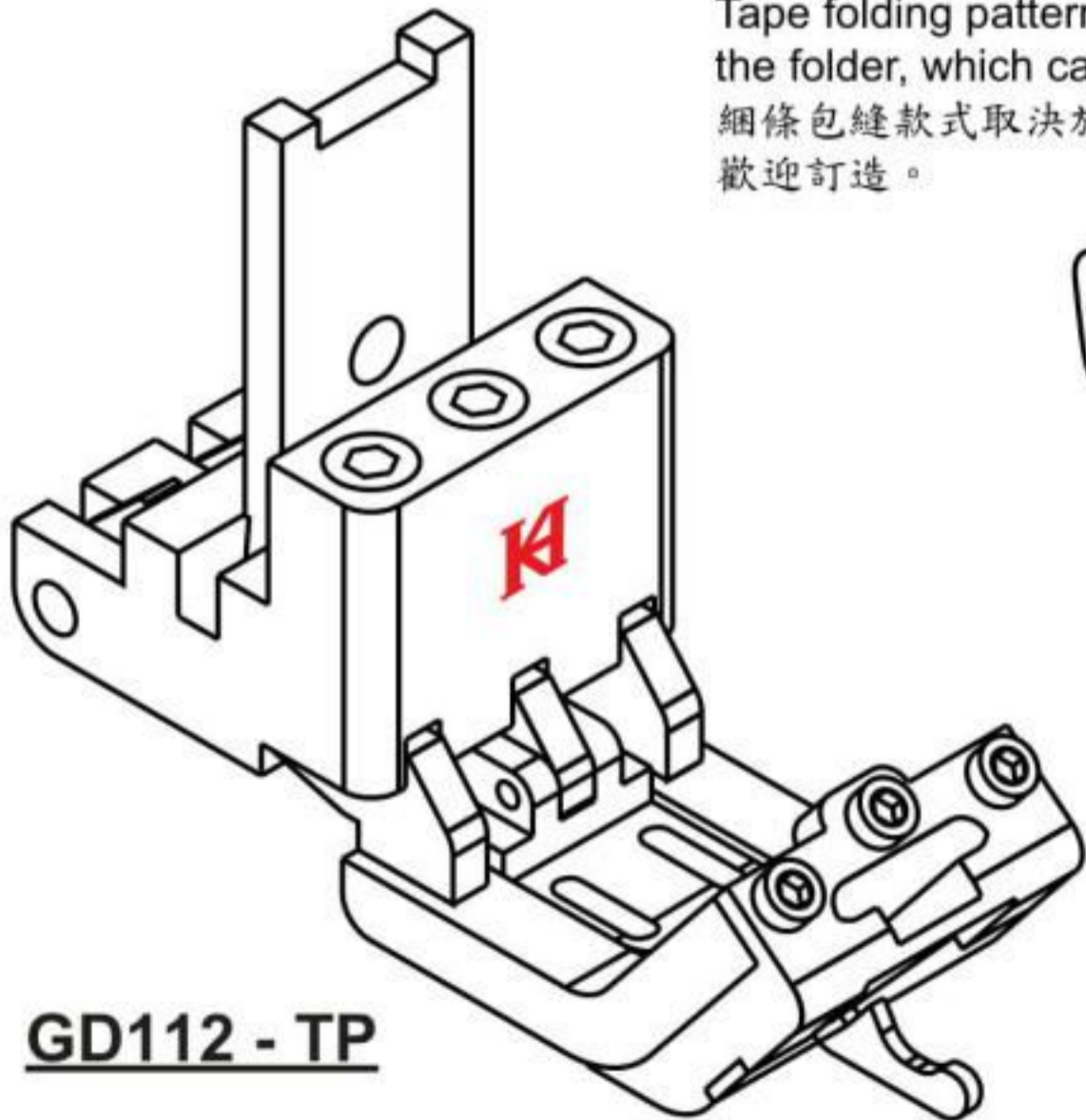

GD112 - TP

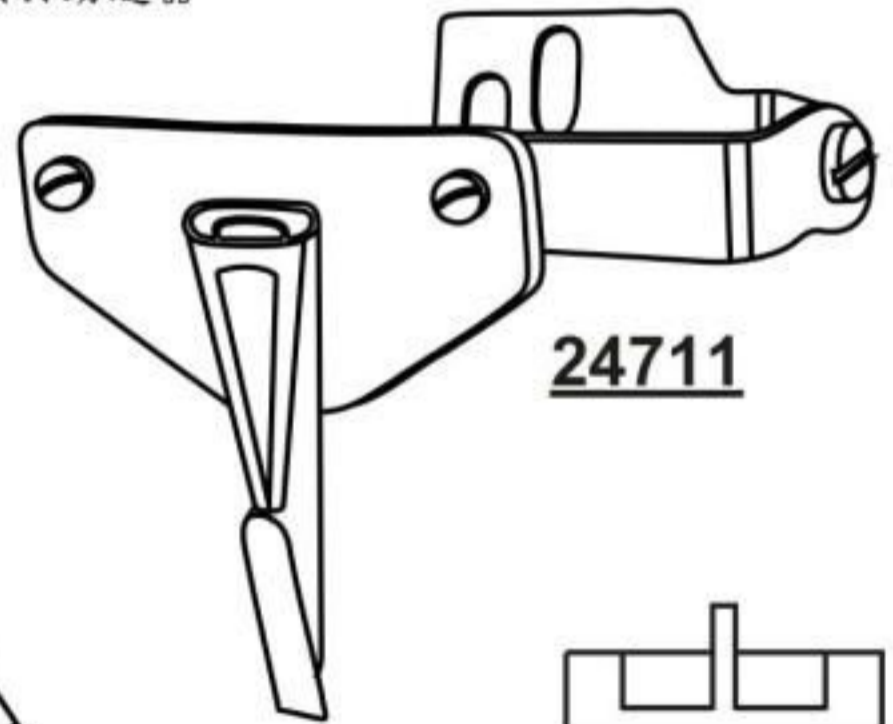

24711

針距 Needle Space	坑距 Guiding Width
5/16"	1/2"

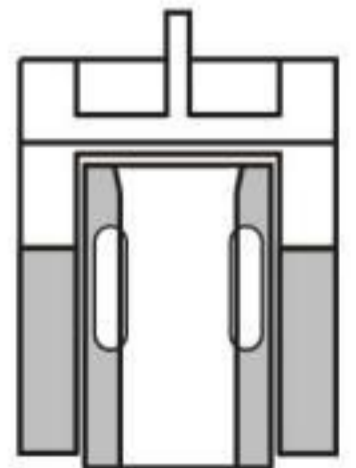

---



---



---



# KEC-2284-GS

(Suitable for 2284/457 Zig Zag Machine)  
(適用於2284/457縫紉機)

## Edge Cutting Gauge Set 人字切刀針位



**Back Drawing**  
背面效果圖:  
Cutting edge simultaneously during sewing  
一邊縫製，一邊切料



**KEC-2284-PP**  
Side Plate 擋板

**Other Optional 另可選購**  
Gauge Set (with Supporting Finger)  
(連刪仔)針位  
**Gauge Set Number 針位編號:**  
**KEC-2284-GSF**

**KEC-2284-T**  
Supporting Finger 刪仔



**KEC-2284-NP**  
Needle Plate 針板

OR

**KEC-2284-NPF**  
針板(連刪仔)  
Needle Plate (with Supporting Finger)

**KEC-2284-PF**  
Presser Foot 壓腳

**KEC-2284-FD**  
Feed Dog 送布牙



Applicable 可另選購:  
**KHF-2284**  
Folder 助縫器

**Needle plate Reverse Assembly Diagram**  
針板反面分解圖

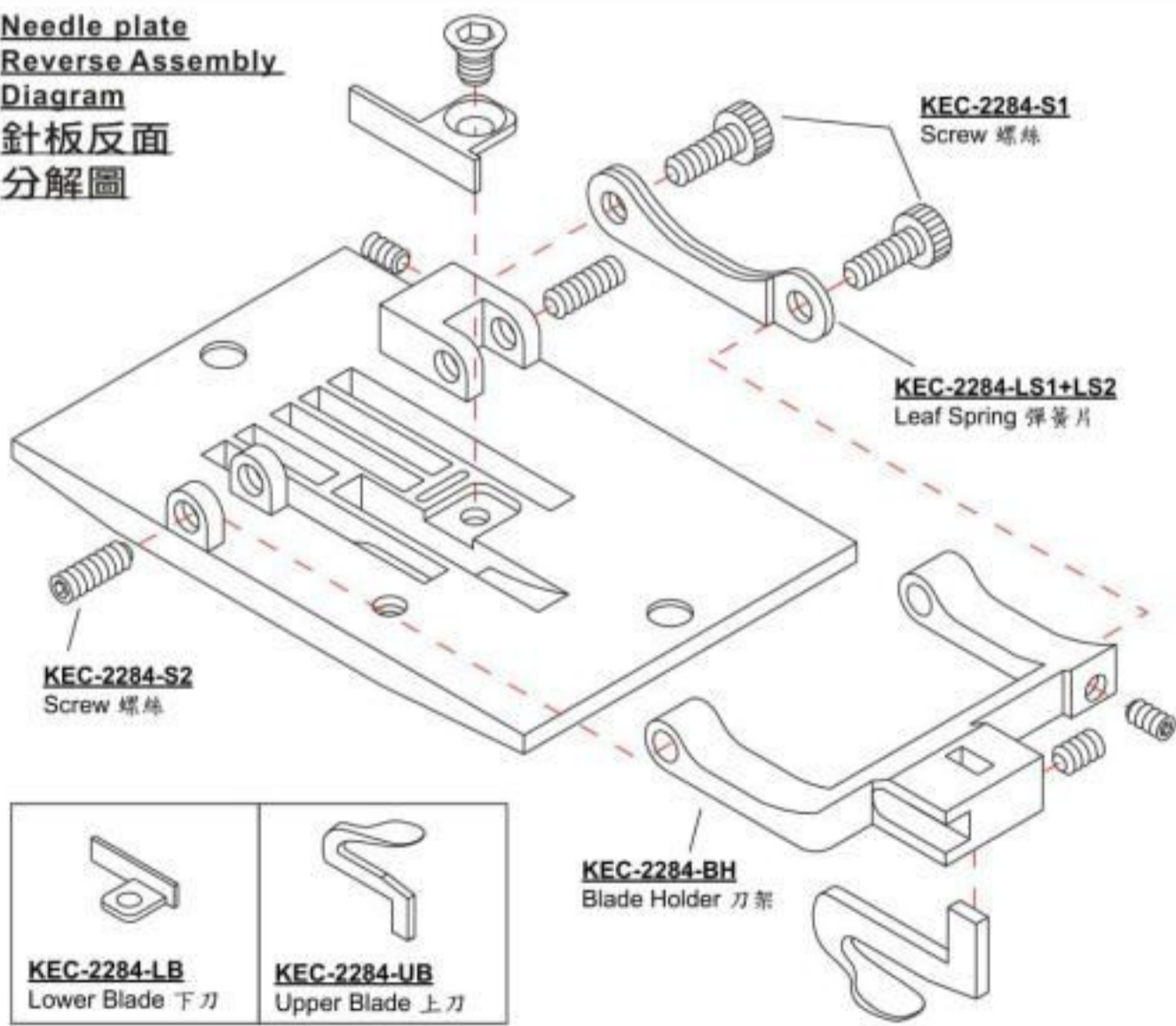

# MD-4 NEW

Digital Synchronous  
Multi-position Tape Feeder & Puller

數碼同步拉/送裝置

## KHF 150

助縫器為訂造產品，  
因應出入口尺寸訂造，  
不包括在MD-4內。

The folder is not included  
in MD-4. It is a tailor-made  
item, which depend on the  
tape size & finished size.

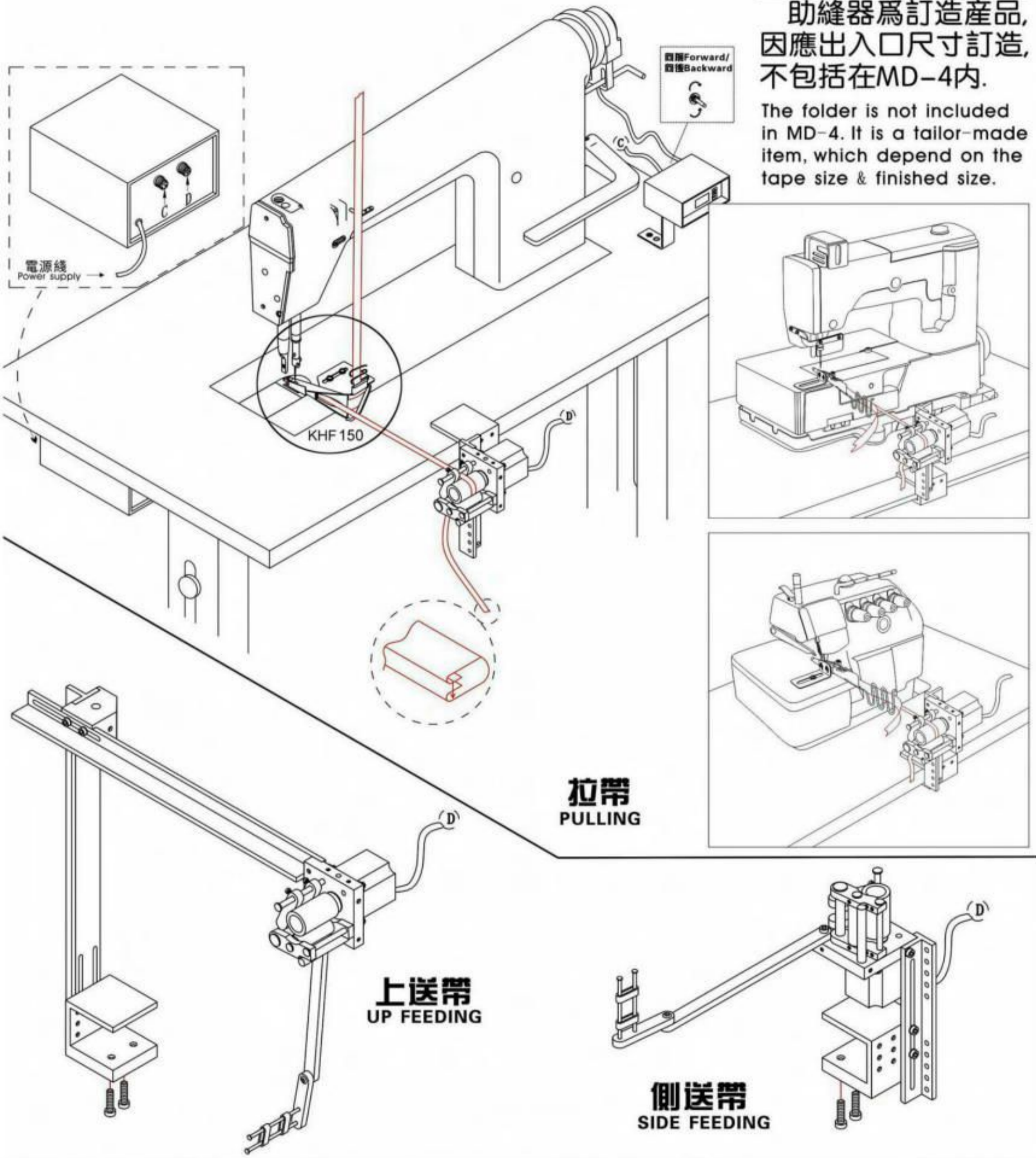

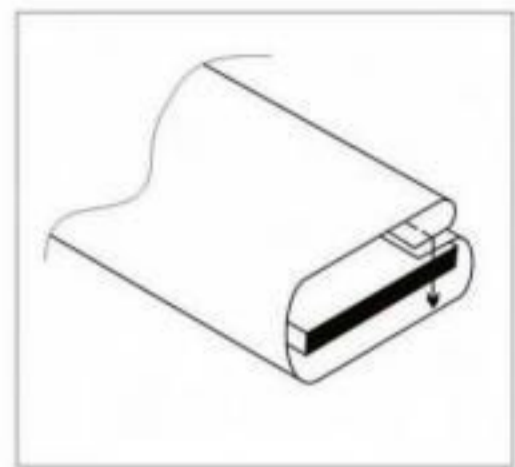
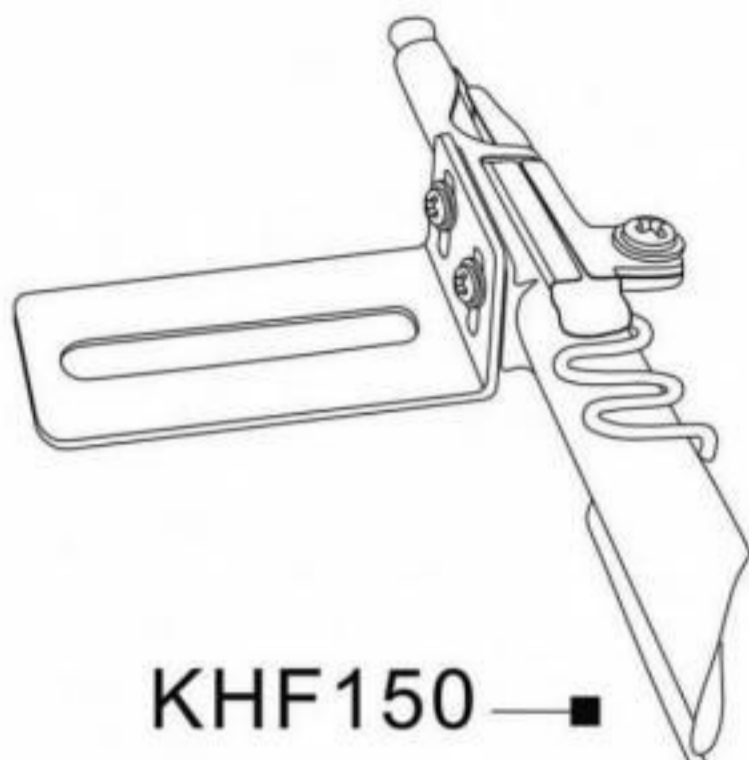
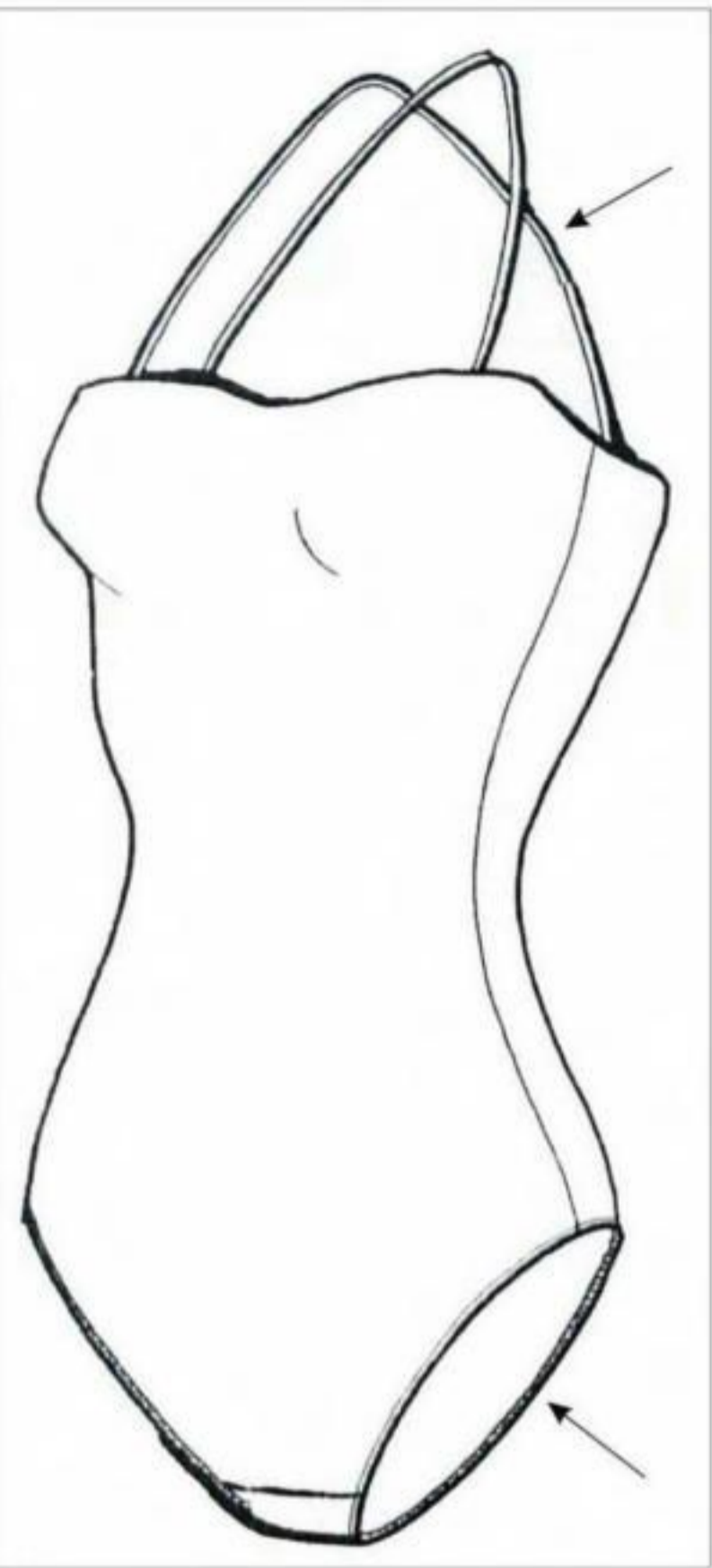

### KHF150

可用於包縫及繃縫機，把細條拉成帶，連上鬆緊帶。縫後，由裡朝外拉出，變成隱藏縫線及內藏鬆緊帶的帶子。

KHF150 is for safty stitch and cover stitch machine. It fold the tape as a strap and join with a elastic. After sewing, pull the tape inside out and make it as a blind sewn strap with a inbuilt elastic.

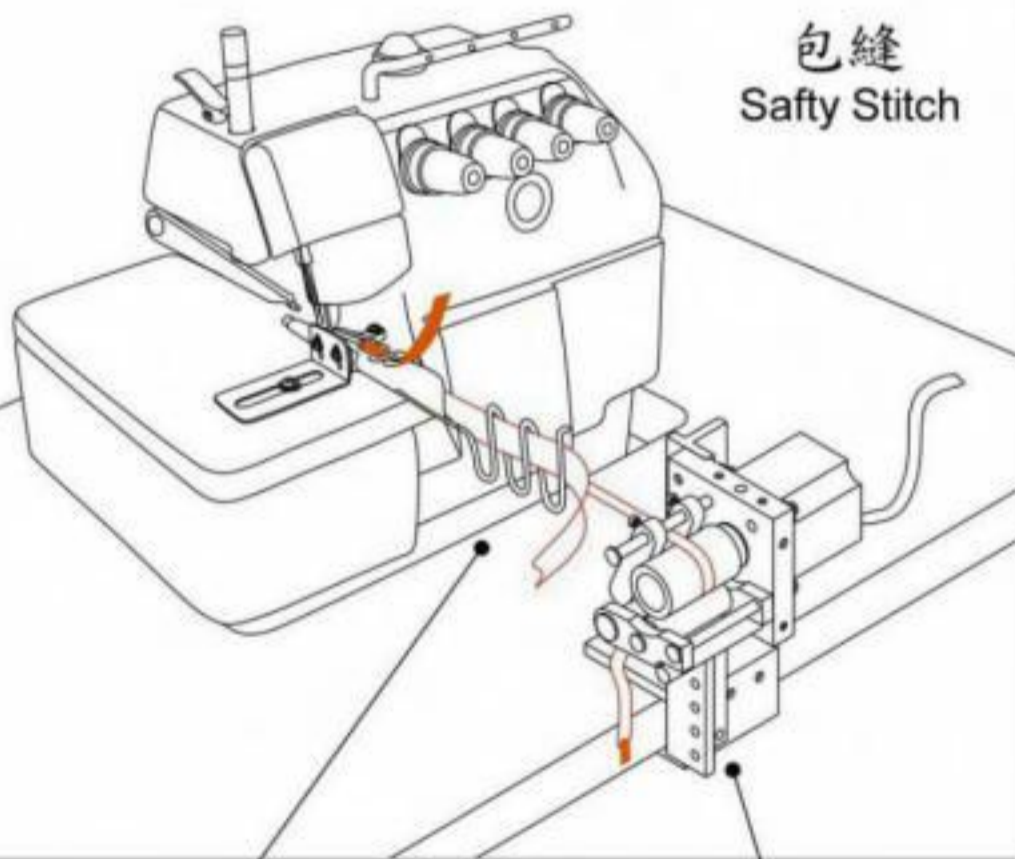
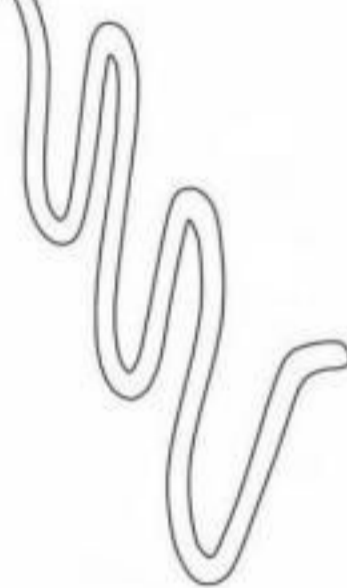

包縫  
Safty Stitch

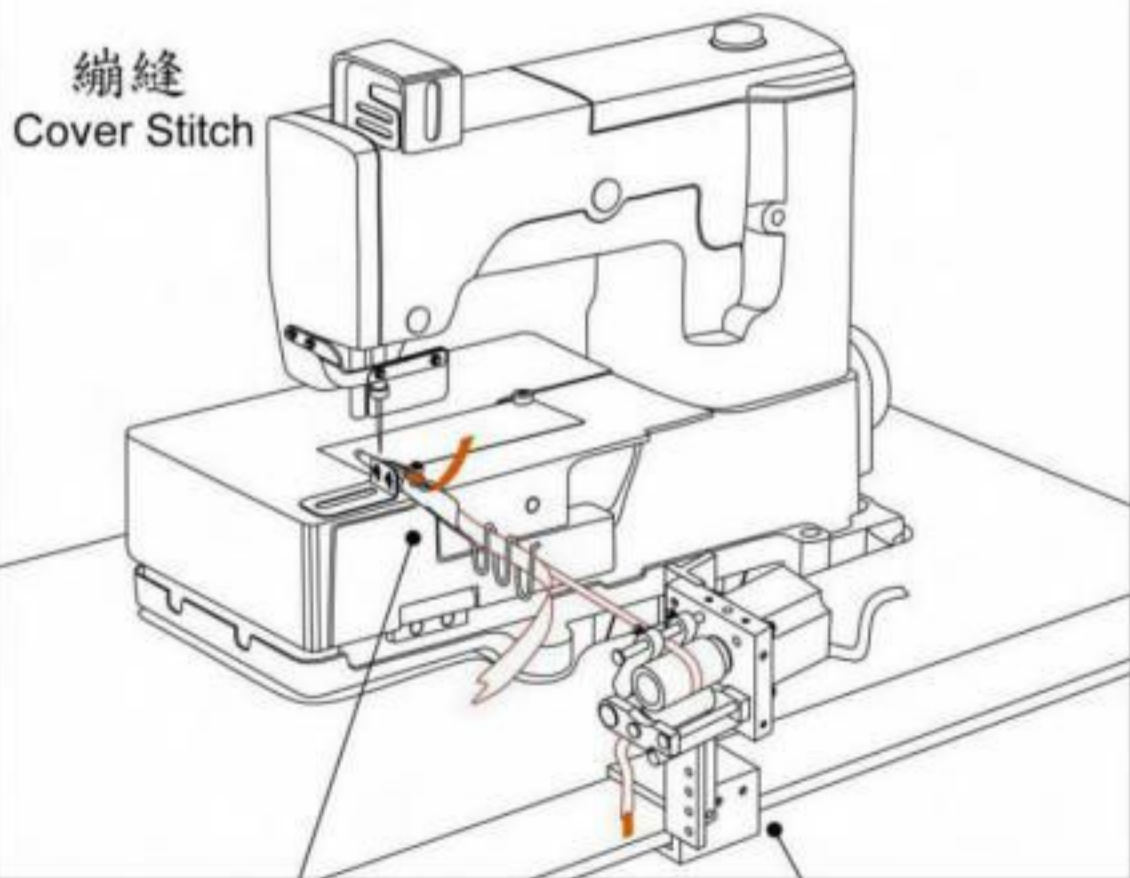

繃縫  
Cover Stitch

KHF150

MD-4

KHF150

MD-4



*Spare Parts &  
Attachment of Lingerie*

*Spare Parts &  
Attachment of Lingerie*

女仕服裝縫製設備  
SPARE PARTS & ATTACHMENT OF  
LINGERIE

МОСКВА



+79161127235  
info@mintex.ru